

SONY

FM/AM MiniDisc Player

Operating Instructions _____

US

Owner's Record

The model and serial numbers are located on the bottom of the unit.

Record the serial number in the space provided below.

Refer to these numbers whenever you call upon your Sony dealer regarding this product.

Model No. MDX-C8970 Serial No. _____

For installation and connections, see the supplied installation/connections manual.



 **Voice Drive**

The Voice Drive logo features a stylized graphic of three concentric arcs above the words "Voice Drive" in a bold, sans-serif font.

MDX-C8970

© 1999 by Sony Corporation

Warning

This equipment has been tested and found to comply with the limits for a Class B digital device, pursuant to Part 15 of the FCC Rules. These limits are designed to provide reasonable protection against harmful interference in a residential installation. This equipment generates, uses, and can radiate radio frequency energy and, if not installed and used in accordance with the instructions, may cause harmful interference to radio communications. However, there is no guarantee that interference will not occur in a particular installation. If this equipment does cause harmful interference to radio or television reception, which can be determined by turning the equipment off and on, the user is encouraged to try to correct the interference by one or more of the following measures:

- Reorient or relocate the receiving antenna.
- Increase the separation between the equipment and receiver.
- Connect the equipment into an outlet on a circuit different from that to which the receiver is connected.
- Consult the dealer or an experienced radio/TV technician for help.

You are cautioned that any changes or modifications not expressly approved in this manual could void your authority to operate this equipment.

CAUTION

The use of optical instruments with this product will increase eye hazard.

Welcome !

Thank you for purchasing this Sony MiniDisc Player. This unit lets you enjoy a variety of features by using either a supplied rotary commander or an optional wireless remote.

In addition to the MD playback and radio operations, you can expand your system by connecting an optional CD/MD unit*¹. When you operate this unit with a connected optional CD unit compatible with the CD TEXT function, the CD TEXT information will appear in the display when you play back a CD TEXT disc*².

*¹ You can also connect a CD changer or an MD changer.

*² A CD TEXT disc is an audio CD that includes information such as the disc name, artist name and track names. This information is recorded on the disc.

You can select for the display language and vocalized comments of the voice guide in either English or French.

Voice Drive

Sony has developed a new function which contributes to safer driving.

In addition to our unique rotary commander, we now introduce a voice sensitive operating system Voice Drive which gives the driver voice control of the car audio.

Now, while keeping your eyes on the road, you can command operations with Voice Drive and confirm results with Voice Guide.

And you can also record your voice with the voice memo function. It will take a note for you when you see or think of something while you are driving.

Voice guide for safe driving

This unit has a voice guide function*. When the voice guide function is on, the unit gives vocalized comments on functions corresponding the relevant button pushed. These comments can be vocalized in either English or French.

* Some optional power amplifiers may cause a break at the beginning of vocalized comments. When you connect an optional MD changer, the sound from the first MD may continue for a short time even after the vocalized comments about the second MD are announced.

Table of Contents

This Unit Only

Notes on MDs	4
Location of controls	5

Getting Started

Resetting the unit	7
Detaching the front panel	7
Preparing the rotary commander	8
Setting the clock	8

MD Player

Listening to an MD	9
Playing an MD in various modes	10
Creating a program	
— MD Program Memory	11

Radio

Memorizing stations automatically	
— Best Tuning Memory (BTM)	13
Memorizing only the desired stations	13
Receiving the memorized stations	13
Storing the station names	
— Station Memo	14
Locating a station by name	
— List-up	15

Voice Drive

Selecting a "V Drive" box for registration	16
Registering a vocal phrase	16
Requesting a registered source	17

Voice Memo

Recording a voice memo	18
Playing back the voice memo	18
Erasing the voice memo	18

DSP

Setting the equalizer	19
Selecting the listening position	19
Selecting a soundstage menu	
— Dynamic Soundstage Organizer (DSO)	20
Adjusting the balance (BAL)	21
Adjusting the fader (FAD)	21
Adjusting the volume of the subwoofer(s)	22
Listening to each program source in its registered DSO	
— Source Sound Memory (SSM)	23

Other Functions

Using the rotary commander	2
Attenuating the sound	2
Changing the sound and display settings	2
Changing the equalizer display	2

With Optional Equipment

CD/MD Unit

Playing a CD or MD	26
Playing tracks repeatedly	
— Repeat Play	28
Playing tracks in random order	
— Shuffle Play	28
Creating a program	
— Program Memory (CD/MD unit with the program memory function)	28
Labeling a CD	
— Disc Memo (CD unit with the custom file function)	31
Locating a disc by name	
— List-up (CD unit with the custom file function or MD unit)	32
Selecting specific tracks for playback	
— Bank (CD unit with the custom file function)	33

TV/Video

Watching the TV	34
Watching a video	34
Memorizing TV channels automatically	34
Memorizing only the desired TV channels	34
Storing the TV channel names	35
Displaying the information stored on discs	35
Watching the TV or video while listening to a CD or MD	
— Simultaneous Play	36

Additional Information

Precautions	37
Maintenance	37
Dismounting the unit	38
Specifications	39
Troubleshooting guide	40

Notes on MDs

Since an MD itself is housed in a cartridge, free from accidental contact with your fingers and dust etc., it can withstand a certain degree of the rough handling. However, dirt or dust on the surface of the cartridge or a warped cartridge may cause a malfunction, observe the following.

Never touch the surface of the MD itself by deliberately opening the shutter on the cartridge.

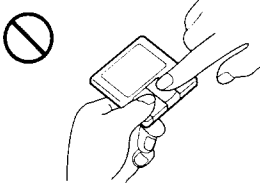

Do not expose the MD to direct sunlight or heat sources such as hot air-ducts. Do not leave it in a car parked in the direct sunlight where there can be a considerable rise in temperature. Make sure that it is not left on the dashboard or rear tray of a car, etc. where the temperature can also be excessive.

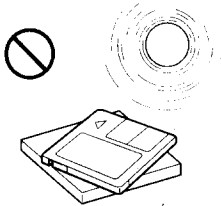

Notes on mounting labels

Be sure to mount labels on cartridges correctly, as failing to do so may cause an MD to become stuck in the unit.

- Mount the label in a suitable position.

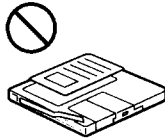

- Remove old labels before putting new ones on.

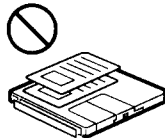

- Replace labels that are beginning to peel away from the MD.

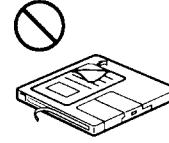

Note on using MDs

If you have drink holders near your audio equipment, be careful not to splash juice or other soft drinks onto the car audio and MDs. Sugary residues spilt on this unit or on the MDs may contaminate the unit and MDs, reduce the sound quality, or prevent sound reproduction altogether.

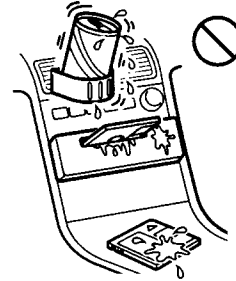

Cleaning

Wipe the surface of the MD cartridge from time to time with a soft dry cloth.

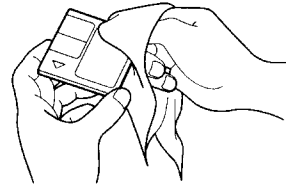

Location of controls

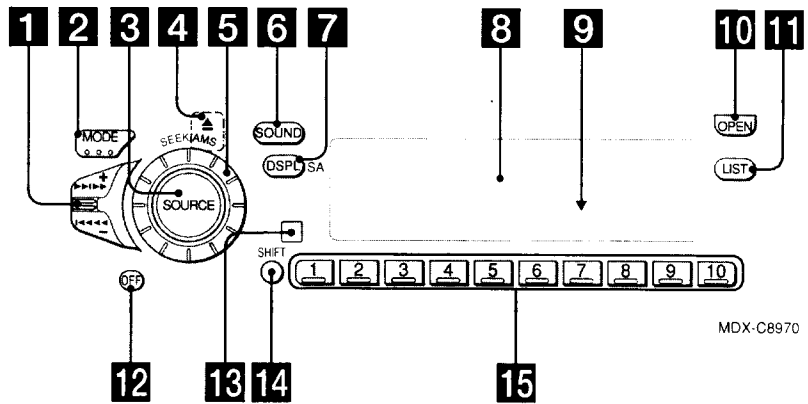

Refer to the pages for details.

- 1** SEEK/AMS (seek/Automatic Music Sensor/manual search/voice drive/voice memo select) control 10, 11, 12, 13, 14, 16, 18, 27, 28, 30, 33, 34
- 2** MODE (band/unit select) button 13, 26, 28, 32, 34
- 3** SOURCE (TUNER/MD/CD) button 9, 13, 19, 20, 21, 22, 26, 28, 32, 34, 36
- 4** (eject) button (located on the front side of the unit behind by the front panel) 9
- 5** Dial (volume/DSO level/equalizer level/listening position/front or rear speaker volume/subwoofer volume/balance) 8, 15, 18, 19, 20, 21, 22, 23, 31, 32
Dial usually functions as a volume control except in some adjusting modes.
- 6** SOUND button 19, 20, 21, 22, 23
- 7** DSPL/SA (display mode/spectrum analyzer change) button 9, 10, 14, 15, 26, 27, 31, 32
- 8** Display window
- 9** Reset button (located on the front side of the unit behind by the front panel) 7
- 10** OPEN button 7, 9, 37
- 11** LIST button
Station Memo 14, 15, 35
List-up 15, 32
Disc Memo 31, 32, 35
- 12** OFF button* 7, 9
- 13** Sensor for the optional wireless remote
- 14** SHIFT button
PLAY MODE 11, 12, 13, 14, 28, 29, 30, 33, 34
REP 10, 28
SET UP 8, 10, 26, 27
SHUF 10, 28
- 15** During radio reception:
Number buttons 13
During CD/MD playback:
Direct disc selection buttons 27
During TV reception:
Number buttons 34

*** Warning when installing in a car without ACC (accessory) position on the ignition key switch**
Be sure to press **OFF** on the unit for two seconds to turn off the clock display after turned off the engine.
When you press **OFF** momentarily, the clock display does not turn off and this causes battery wear.

Location of controls

Optional wireless remote (RM-X47)

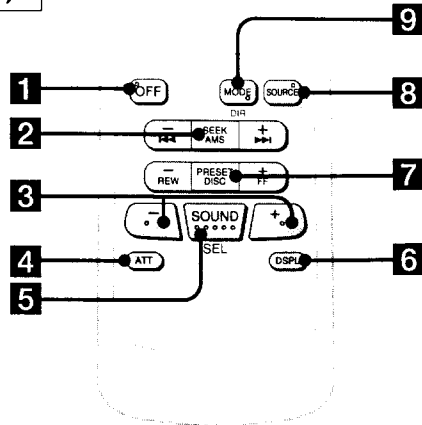

The buttons of the wireless remote have the same functions as those on the unit.

- | | |
|---------------------------|--|
| 1 OFF button | 6 DSPL button |
| 2 SEEK/AMS button | 7 PRESET/DISC button
<i>You cannot do manual search and manual tuning with the remote.</i> |
| 3 buttons | 8 SOURCE button |
| 4 ATT button | 9 MODE/DIR button |
| 5 SOUND/SEL button | |

Getting Started

Resetting the unit

Before operating the unit for the first time or after replacing the car battery, you must reset the unit.

Press the reset button with a pointed object, such as a ball-point pen.

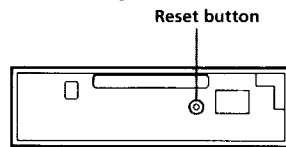

Notes

- Pressing the reset button will erase the clock and some memorized functions.
- When you connect the power supply cord to the unit or reset the unit, wait for about 10 seconds before you insert a disc. If you insert a disc within these 10 seconds, the unit will not be reset, and you will have to press the reset button again.

Detaching the front panel

You can detach the front panel of this unit to protect the unit from being stolen.

- 1 Press **OFF**.
- 2 Press **OPEN** to open up the front panel, then slide the front panel to the right side, and pull out from the left side of the front panel.

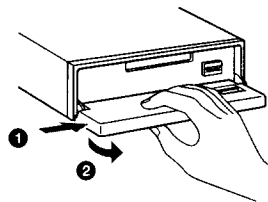

Notes

- Do not place anything on the inner surface of the front panel.
- Be sure not to drop the panel when detaching it from the unit.
- If you detach the panel while the unit is still on, the power will be turned off automatically to prevent the speakers from being damaged.
- When you carry the front panel with you, put it in the supplied front panel case.

Attaching the front panel

Place the hole ④ in the front panel onto the spindle ⑤ on the unit as illustrated, then push the left side in.

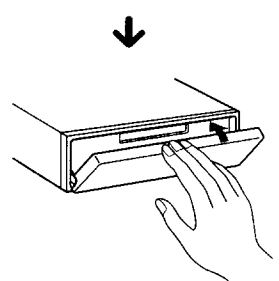
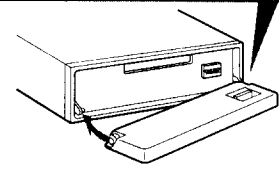
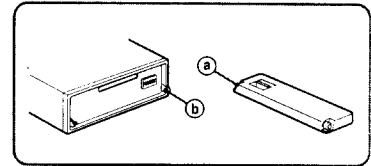

Notes

- Be sure not to attach the front panel upside down.
- Do not press the front panel hard against the unit when attaching it. Press it lightly against the unit.
- Do not press hard or put excessive pressure on the display windows of the front panel.
- Do not expose the front panel to direct sunlight or heat sources such as hot air ducts, and do not leave it in a humid place. Never leave it on the dashboard of a car parked in direct sunlight where there may be a considerable rise in temperature.

Caution alarm

If you turn the ignition key switch to the OFF position without removing the front panel, the caution alarm will beep for a few seconds.

Preparing the rotary commander

When you mount the rotary commander, attach the label as shown in the illustration below.

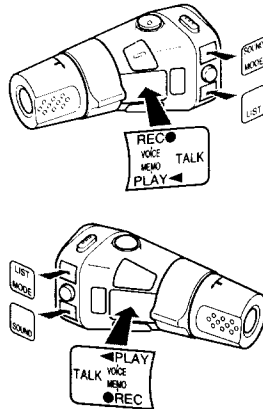

Setting the clock

The clock uses a 12-hour digital indication.

Example: To set the clock to 10:08

- 1 Press **(SHIFT)**, then press **(3) (SET UP)** repeatedly until "Clock" appears.

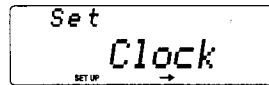

- 1 Press **(5) (→)**.

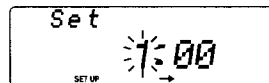

The hour digit flashes.

- 2 Set the hour.

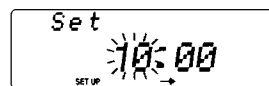
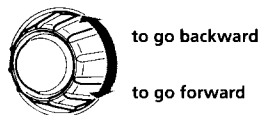

- 3 Press **(5) (→)**.

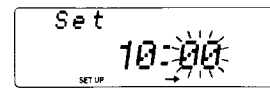

The minute digits flash.

- 4 Set the minute.

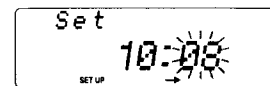
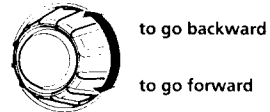

- 2 Press **(SHIFT)**.

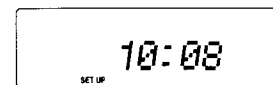

The clock starts.

- 3 Press **(SHIFT)**.

After the mode setting is complete, the display returns to the normal playback mode.

MD Player

Listening to an MD

- 1 Press **(OPEN)** and insert the MD.
Playback starts automatically.

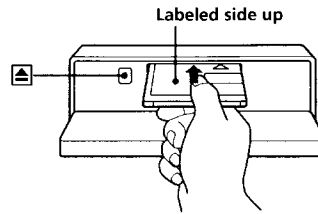

- 2 Close the front panel.

If an MD is already inserted, press **(SOURCE)** repeatedly until "MD" appears.

The title of the MD* and the track title will be displayed on the display window, then the playing time will appear.

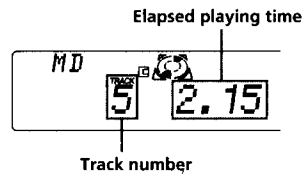

* Only if these titles are prerecorded on the MD.

When the last track on the MD is over

The track number indication will return to "1," and the playback will restart from the first track of the MD.

To	Press
Stop playback	(OFF)
Eject the MD	(OPEN) then ▲

Changing the display/SA item

Each time you press **(DISPL/SA)**, the item changes as follows:

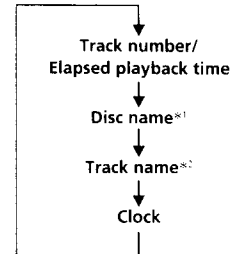

*1 If there is no prerecorded title for a disc "NO D.Name" will appear on the display.

*2 If a track title is not prerecorded, "NO T.Name" will be displayed.

After you select the desired item, the display will automatically change to the Motion Display mode after a few seconds. In the Motion Display mode, all the above items are scrolled in the display one by one in order.

Tips

- If the name of the MD is too long, you can scroll it across the display window by pressing **(SHIFT)** then press **(2) (←)** while the disc name or track name is displayed.
- The Motion Display mode can be turned off. (See "Changing the sound and display settings" on page 25.)

Automatically scrolling a disc name

— Auto Scroll

If the disc name or track name on an MD exceeds 10 characters and the Auto Scroll function is on, automatically scrolls on the display as follows:

- The disc name appears when the disc has changed (if the disc name is selected).
- The track name appears when the track has changed (if the track name is selected).
- The disc or track name appears depending on the setting when you press (SOURCE) to select an MD.

If you press (DSP/SA) to change the display item, the disc or track name of the MD is scrolled automatically whether you set the function on or off.

- 1 During playback, press (SHIFT).
- 2 Press (3) (SET UP) repeatedly until "A.Scrl" appears.
- 3 Press (5) (→) to select "A.Scrl on."
- 4 Press (SHIFT).

To cancel Auto Scroll, select "A.Scrl off" in step 3 above.

Locating a specific track

— Automatic Music Sensor (AMS)

During playback, push the SEEK/AMS control up or down momentarily.

To locate succeeding tracks

To locate preceding tracks



Locating a specific point in a track

— Manual Search

During playback, push the SEEK/AMS control up or down and hold. Release when you have found the desired point.

To search forward

To search backward



Note

If "LLLL" or "RRRR" appears in the display, that means you have reached the beginning or the end of the disc and you cannot go any further.

Playing an MD in various modes

You can play MDs in various modes:

- Repeat (Repeat Play) repeats the current track.
- Shuf (Shuffle Play) plays all the tracks in random order.

Playing tracks repeatedly

— Repeat Play

- 1 During playback, press (SHIFT).
- 2 Press (7) (REP) repeatedly until "Repeat 1" appears.

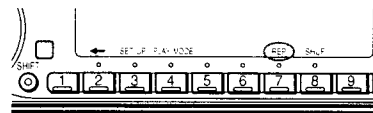

Repeat Play starts.

- 3 Press (SHIFT).

To return to the normal playback mode, select "Repeat off" in step 2 above.

Playing tracks in random order

— Shuffle Play

- 1 During playback, press (SHIFT).
- 2 Press (8) (SHUF) repeatedly until "Shuf 1" appears.

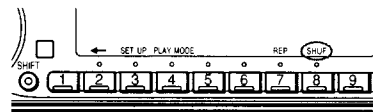

Shuffle Play starts.

- 3 Press (SHIFT).

To return to the normal playback mode, select "Shuf off" in step 2 above.

Creating a program

— MD Program Memory

You can play the tracks in any order you want by making your own programs. You can select up to 24 tracks for a program. You can store the programs in memory.

- 1 During MD playback, press (SHIFT), then press (4) (PLAY MODE) for two seconds.



- 2 Push the SEEK/AMS control up or down to select the track you want.

- 3 Press (6) (ENTER) momentarily.



- 4 To continue entering tracks, repeat steps 2 and 3.

- 5 When you finish selecting tracks, press (4) (PLAY MODE) for two seconds.

- 6 Press (SHIFT).

Notes

- "Wait" appears in the display while the unit is reading the data.
- "Mem Full" appears in the display when you try to enter more than 24 tracks into a program.

Playing the stored program

- 1 Press (SHIFT).

- 2 Press (4) (PLAY MODE) repeatedly until "PGM" appears.

- 3 Press (5) (→) repeatedly until "PGM on" appears.



Program Play starts.

- 4 Press (SHIFT).

To return to the normal playback mode, select "PGM off" in step 3 above.

Notes

- "No data" appears in the display if no track is stored in the program.
- "Not ready" appears in the display if a disc that has no programmed tracks is inserted.

Erasing an entire program

- 1 Press (SHIFT), then press (4) (PLAY MODE) for two seconds.

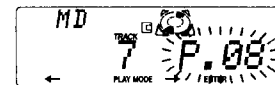

- 2 Press (2) (←) repeatedly until "DEL" appears.



- 3 Press (6) (ENTER) for two seconds.



The entire program is erased.

- 4 When you finish erasing programs, press (4) (PLAY MODE) for two seconds.

- 5 Press (SHIFT).

Adding tracks to a program

- 1 Press **(SHIFT)**, then press **(4)** (PLAY MODE) for two seconds.



- 2 Press **(2)** (←) or **(5)** (→) to select the track slot number where you want to insert a track.

Track slot number



- 3 Push the SEEK/AMS control up or down to select the track you want to insert.

- 4 Press **(6)** (ENTER) momentarily to enter the track.

The current track is inserted in that slot number and the succeeding tracks shift down.

- 5 To continue inserting tracks, repeat steps 2 through 4.

Note

Once all 24 slots have been filled, "Mem Full" appears in the display, and you cannot insert more tracks.

- 6 When you finish inserting tracks, press **(4)** (PLAY MODE) for two seconds.

- 7 Press **(SHIFT)**.

Erasing tracks in a program

- 1 Press **(SHIFT)**, then press **(4)** (PLAY MODE) for two seconds.



- 2 Press **(2)** (←) or **(5)** (→) to select the track you want to erase.

Track slot number



The track currently registered in slot 6.

- 3 Press **(6)** (ENTER) for two seconds.

When you erase a track from a slot number, the succeeding tracks shift up to fill the gap.



- 4 To continue erasing tracks, repeat steps 2 and 3.

- 5 When you finish erasing tracks, press **(4)** (PLAY MODE) for two seconds.

- 6 Press **(SHIFT)**.

Radio

Memorizing stations automatically

— Best Tuning Memory (BTM)

The unit selects the stations with the strongest signals and memorizes them in the order of their frequencies. You can store up to 10 stations on each band (FM1, FM2, and AM).

Caution

When tuning in stations while driving, use Best Tuning Memory to prevent accidents.

- 1 Press **(SOURCE)** repeatedly to select the tuner.
Each time you press **(SOURCE)**, the source changes as follows:
MD ↔ TUNER
- 2 Press **(MODE)** repeatedly to select the band.
Each time you press **(MODE)**, the band changes as follows:
→ FM1 → FM2 → AM
- 3 Press **(SHIFT)**, then press **(4)** (PLAY MODE) repeatedly until "B.T.M" appears.
- 4 Press **(5)** (→).
The unit stores stations in the order of their frequencies on the number buttons.
A beep sounds when the setting is stored.
- 5 Press **(SHIFT)**.

Notes

- The unit does not store stations with weak signals. If only a few stations are received, some number buttons will retain their former setting.
- When a number is indicated in the display, the unit starts storing stations from the one currently displayed.

Memorizing only the desired stations

You can preset up to 20 FM stations (10 for FM1 and 10 for FM2) and up to 10 AM stations in the order of your choice.

- 1 Press **(SOURCE)** repeatedly to select the tuner.
- 2 Press **(MODE)** repeatedly to select the band (FM1, FM2, or AM).
- 3 Push the SEEK/AMS control up or down to tune in the station you want to store on the number button.
- 4 Press and hold the desired number button (**(1)** to **(10)**) until "MEM" appears.
The number button indication appears in the display.

Note

If you try to store another station on the same number button, the previously stored station will be erased.

Receiving the memorized stations

- 1 Press **(SOURCE)** repeatedly to select the tuner.
- 2 Press **(MODE)** repeatedly to select the band (FM1, FM2, or AM).
- 3 Press the number button (**(1)** to **(10)**) momentarily where the desired station is stored.

If you cannot tune in a preset station

Push the SEEK/AMS control up or down momentarily to search for the station (automatic tuning).

Scanning stops when the unit receives a station. Push the SEEK/AMS control up or down repeatedly until the desired station is received.

Note

If the automatic tuning stops too frequently, press (SHIFT), then press (4) (PLAY MODE) repeatedly until "Local" (local seek mode) is displayed. Then press (5) (→) to select "Local on." Press (SHIFT). Only the stations with relatively strong signals will be tuned in.

Tip

If you know the frequency of the station you want to listen to, push the SEEK/AMS control up or down and hold until the desired frequency appears (manual tuning).

If FM stereo reception is poor

— Monaural Mode

1 Press (SHIFT), then press (4) (PLAY MODE) repeatedly until "Mono" appears.

2 Press (5) (→) repeatedly until "Mono on" appears.

The sound improves, but becomes monaural ("ST" disappears).

3 Press (SHIFT).

To return to the normal mode, select "Mono off" in step 2 above.

If interference occurs during FM reception

If there is interference from neighboring stations, follow the steps below and select "Narrow." If interference is not a problem, select "Wide" to maximize signal reception and improve sound quality or "IF Auto" to switch between "Narrow" and "Wide" automatically.

1 Press (SHIFT) during FM reception.

2 Press (4) (PLAY MODE) repeatedly until "IF Auto" appears.

3 Press (5) (→) repeatedly to select desired setting.

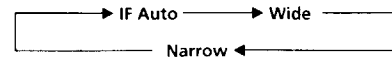

4 Press (SHIFT).

Changing the display item

Each time you press (DSPL/SA), the item changes as follows:

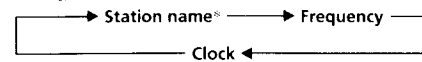

* If the station name is not stored, "NO Name" appears in the display for one second.

After you select the desired item, the display will automatically change to the Motion Display mode after a few seconds.

In the Motion Display mode, all the above items are scrolled in the display one by one in order.

Tip

The Motion Display mode can be turned off. (See "Changing the sound and display settings" on page 25.)

Storing the station names

— Station Memo

You can assign a name to each radio station and store it in memory. The name of the station currently tuned in appears in the display. You can store up to eight characters for a station.

Storing the station names

1 Tune in a station whose name you want to store.

2 Press (LIST) for two seconds.

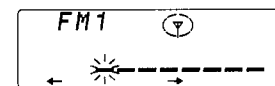

3 Enter the characters.

- 1 Rotate the dial clockwise to select the desired characters.

(A → B → C → ... Z → 0 → 1 → 2 → ... 9 → + → - → * → / → \ → > → < → . → _)

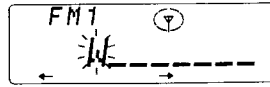

If you rotate the dial counterclockwise, the characters appear in the reverse order.

If you want to put a blank space between characters, select “_” (under-bar).

- 2 Press (→) after locating the desired character.

The flashing cursor moves to the next space.

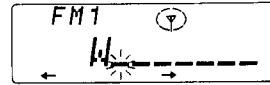

If you press (←), the flashing cursor moves to the left.

- 3 Repeat steps 1 and 2 to enter the entire name.

- 4 To return to the normal radio reception, press (LIST) for two seconds.

Tip

To erase or correct a name, enter “_” (under-bar) for each character.

Displaying the station name

Press (DSPL/SA) during radio reception.

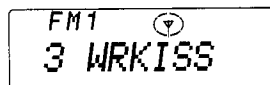

Each time you press (DSPL/SA), the item changes as follows:

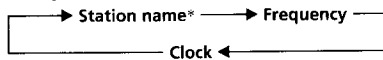

* If the station name is not stored, “NO Name” appears in the display for one second.

Erasing the station name

- 1 Tune in any station and press (LIST) for two seconds.

- 2 Press (DSPL/SA) for two seconds. The station name appears in the display.

- 3 Rotate the dial to select the name that you want to erase.

- 4 Press (ENTER) for two seconds. The name is erased. Repeat steps 3 and 4 if you want to erase other names.

- 5 Press (LIST) for two seconds. The unit returns to the normal radio reception mode.

Locating a station by name — List-up

- 1 Press (LIST) momentarily. The name assigned to the current station appears in the display.

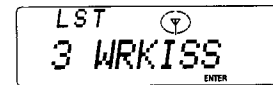

- 2 Press (LIST) repeatedly until you find the desired station.

- 3 Press (ENTER) to tune in the desired station.

Note

After the station name or frequency has been displayed for five seconds, the display returns to normal mode. To turn off the display, press (DSPL/SA).

Voice Drive

You can register an appropriate vocal phrase for any source including CD/MD*, and the radio station. Once the registration is completed, you can request that source just by pronouncing the registered vocal phrase for it towards the supplied microphone. This unit provides 12 "V Drive" boxes for accommodating registered phrases.

When you connect to a CD/MD changer with a PGM (Program memory) function, you can request a disc in the CD/MD changer.

Use the rotary commander to control this function.

Selecting a "V Drive" box for registration

- 1 Play a CD or MD, or tune in a radio station that you wish to register a phrase for.
- 2 Press and hold **TALK** on the rotary commander until "V Drive" appears.

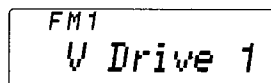

FM1
V Drive 1

Note
When the unit enters the setting mode, the disc playback or the radio reception will be suspended.

Tip
If the "V Drive" box selected in step 2 already has a registered phrase, the source corresponding to it will be played or tuned in.

- 3 Select a "V Drive" box for registration by adjusting the SEEK/AMS control either on the unit or the rotary commander.

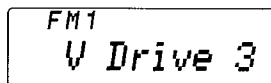

FM1
V Drive 3

Tip
If you select an already registered box number, the registered source will be played or tuned in to.

Registering a vocal phrase

- 1 Once all the steps of "Selecting a "V Drive" box for registration" are completed, press **TALK** on the rotary commander.
- 2 After you hear the unit's vocalized instruction "Please speak now.", pronounce a desired phrase toward the supplied microphone.

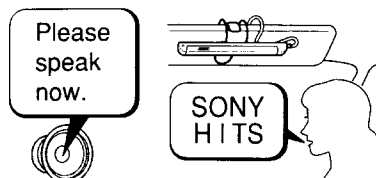

- 3 After the vocalized instruction "Please repeat.", pronounce the same phrase again.

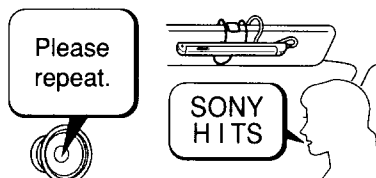

- 4 After another vocalized instruction "Please repeat.", pronounce the same phrase one more time.

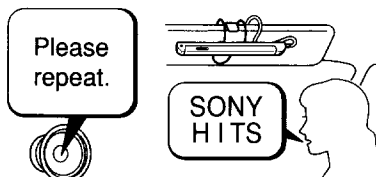

The unit records the vocal phrase in this step in order to identify the registered phrase later. When the unit answers "OK!", the registration is completed.

Notes

- Do not attempt to register while driving, as this may create a traffic hazard.
- Be sure to reply after the unit's vocalized instruction.
- When a beep sound is heard, the registration failed. In this case, repeat the same process starting from step 1.
- Do not use phrases of similar pronunciation such as "Sony POPS 1" and "Sony POPS 2", because the unit may not be able to distinguish the difference.
- After you hear the unit's vocalized instruction, reply within three seconds.

Tips

- When you register the phrases, pronounce them clearly and loudly to make it easier for the unit to recognize them.
- Registration should be made while the car is parked with the engine running so that the unit will recognize your voice more easily when you are driving.
- Though the vocalized instructions are in English, any language can be used for registration.
- The volume of the vocalized instructions can be adjusted on the unit or by the rotary commander.

Requesting a registered source

You can request a registered source while listening to other sources or during the clock display.

- 1 Press **TALK** on the rotary commander.

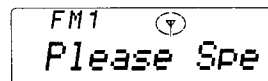

- 2 After you hear the unit's vocalized instruction "Please speak now.", pronounce the registered phrase such as the disc name or the radio station.

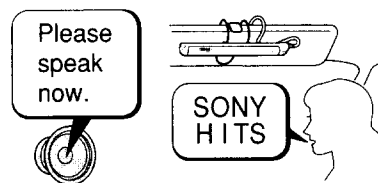

- 3 When the unit successfully recognized the phrase;

The unit will play the disc or tune in the radio station.

When the unit fails to recognize the phrase;

The unit replies "Please speak again."
In this case, repeat the same registered phrase.

Notes

- When the unit fails to recognize the phrase three times, a beep sounds and the unit returns to the previous source. In this case, repeat the same process starting from step 1.
- If it is noisy outside the car, the unit may not recognize the registered phrase. In this case, close the window and try again.
- If you are far from the microphone, speak louder or come nearer to the microphone.

Tips

- If you do not reply within three seconds after the vocalized instruction, the unit replies "Please speak now."
- When you are requesting a registered source, pronounce clearly and loudly to make it easier for the unit to recognize.
- When the unit has difficulty recognizing the phrase, register the vocal phrase again.

Voice Memo

Voice Memo is a function that allows you to record a voiced memorandum, such as the name of a song heard on a radio program or an idea which comes to mind. You can record up to six voice memos with this function. Note that each voice memo must be within 15 seconds.

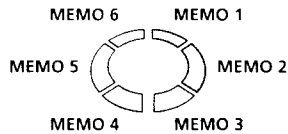

You can record or play back the voice memo when listening to any source or during the clock display.

Use the rotary commander to control this function.

Recording a voice memo

- 1 Press **REC** on the rotary commander and voice your memorandum toward the supplied microphone.

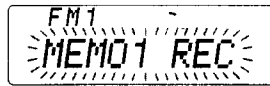

- 2 The recording is completed by pressing **REC** again or leaving the unit untouched for 15 seconds.

Notes

- The voice memos are recorded as "MEMO 1", "MEMO 2", etc.,...in the order they are recorded.
- When a beep sounds and "MEMO FULL" appears, it means there is no room for additional voice memos. In such a case, erase the older recorded voice memos before recording new ones.

Playing back the voice memo

- 1 Press **PLAY** on the rotary commander. The playback starts from MEMO 1.



- 2 Select the desired voice memo using the SEEK/AMS control.

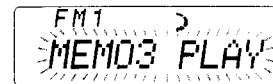

- 3 Adjust the volume on the main unit or by using the rotary commander. The unit automatically returns to the previous source after playing back all of the voice memos.

To interrupt the playback of a voice memo

Press **PLAY** on the rotary commander. Playback stops and the unit automatically returns to the previous source.

Erasing the voice memo

- 1 Play back the voice memo to be erased.
- 2 Press and hold **PLAY** on the rotary commander until a beep sound is heard.

The voice memo will be erased and the numbers of succeeding voice memos will move up respectively.

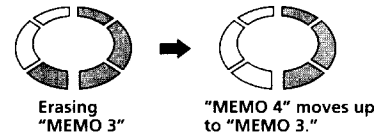

DSP

Setting the equalizer

You can select an equalizer curve for eight music types (Rock, Vocal, Jazz, Classic, Groove, Talk, Techno, and Custom). You can store and adjust the equalizer settings for frequency and level.

Selecting the equalizer curve

- 1 Press **(SOURCE)** to select a source (tuner, CD, or MD).
- 2 Press **(SOUND)** repeatedly until "EQ" appears.



- 3 Rotate the dial to select the desired equalizer curve.

Rock ↔ Vocal ↔ Jazz ↔ Classic ↔ Groove
 ↔ Talk ↔ Techno ↔ Custom ↔ off

To cancel the equalizing effect, select "off." After three seconds, the display returns to the normal playback mode.

Adjusting the equalizer curve

- 1 Press **(SOUND)** for two seconds.
 - 2 Press **(SOUND)** repeatedly until "EQ" appears.
 - 3 Rotate the dial to select the desired equalizer curve.
- Rock ↔ Vocal ↔ Jazz ↔ Classic ↔ Groove
 ↔ Talk ↔ Techno ↔ Custom ↔ off
- 4 Press **(5) (→)**.



- 5 Press **(2) (←)** or **(5) (→)** to select the desired frequency.

62 Hz ↔ 157 Hz ↔ 396 Hz ↔ 1.00 kHz ↔
 2.51 kHz ↔ 6.34 kHz ↔ 16.0 kHz

- 6 Rotate the dial to select the desired level.
 If you want to change the equalizer curve to be adjusted at this time, press **(2) (←)** repeatedly until the equalizer curve name appears to return to step 3.
 To restore the factory-set equalizer curve, press **(6) (ENTER)** for two seconds.

- 7 Press **(SOUND)** for two seconds.
 When the effect setting is complete, the normal playback mode appears.

Selecting the listening position

You can set a delayed time for the sound to reach the listeners from the speakers. In this way, the unit can simulate a natural sound field so that you feel as if you are in the center of the sound field no matter where you sit in the car.

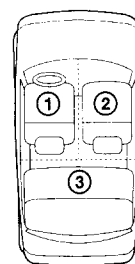

Display window	Center of sound field
POS 1 All	Normal setting (① + ② + ③)
POS 2 Front	Front part (① + ②)
POS 3 Front-R	Right front (②)
POS 4 Front-L	Left front (①)
POS 5 Rear	Rear part (③)
POS off	Cancel

- 1 Press **(SOURCE)** to select a source (tuner, CD, or MD).
- 2 Press **(SOUND)** repeatedly until "POS" appears.

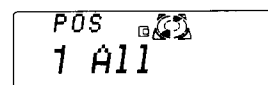

continue to next page →

Rotate the dial to select the desired listening position.

All ↔ Front ↔ Front-R ↔ Front-L ↔ Rear ↔ off

The listening positions appear in the order shown above.

To cancel the POS mode, select "off." After three seconds, the display returns to the normal playback mode.

Adjusting the listening position

Press **(SOUND)** for two seconds.

Press **(SOUND)** repeatedly until "POS" appears.

Press **(5) (→)**.

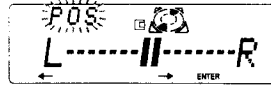

Rotate the dial to adjust the center of the sound field to the left or right.

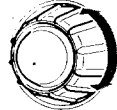

Center moves to the L (left).

Center moves to the R (right).

To restore the factory-set listening position, press **(6) (ENTER)** for two seconds.

Press **(5) (→)**.



Rotate the dial to adjust the center of the sound field to the front or rear.

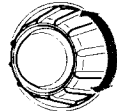

Center moves to the R (rear).

Center moves to the F (front).

To restore the factory-set listening position, press **(6) (ENTER)** for two seconds.

Press **(SOUND)** for two seconds.

When the effect setting is complete, the normal playback mode appears.

Selecting a soundstage menu

— Dynamic Soundstage Organizer (DSO)

If your speakers are installed into the lower part of the doors, the sound will come from below and may not be clear.

The DSO (Dynamic Soundstage Organizer) function creates a more ambient sound as if there were speakers in the dashboard (virtual speakers).

You can adjust the sound to your own preferences to reproduce the ambient qualities of a concert hall or night club.

Soundstage menu

Memory presets	Meaning
1 E-STD	Virtual speakers (standard)
2 ES-CLUB	Virtual speakers (standard) + initial reflection
3 ES-LIVE	Virtual speakers (standard) + reverberation
4 E-WIDE	Virtual speakers (wide)
5 EW-CLUB	Virtual speakers (wide) + initial reflection
6 EW-LIVE	Virtual speakers (wide) + reverberation
7 LIVE	Reverberation
8 CLUB	Initial reflection
off	Cancel

Image of virtual speakers

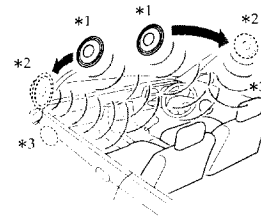

*1 Standard

*2 Wide

*3 Actual speakers position (lower part of the front doors).

Selecting the DSO

- 1 Press **(SOURCE)** to select a source (tuner, CD, or MD).
- 2 Press **(SOUND)** repeatedly until "DSO" appears.



- 3 Rotate the dial to select the desired DSO mode.

1 E-STD ↔ 2 ES-CLUB ↔ 3 ES-LIVE ↔
4 E-WIDE ↔ 5 EW-CLUB ↔ 6 EW-LIVE ↔
7 LIVE ↔ 8 CLUB ↔ off

To cancel the DSO mode, select "off."
After three seconds, the display returns to the normal playback mode.

Adjusting the DSO mode

- 1 Press **(SOUND)** for two seconds.
- 2 Rotate the dial to select the desired DSO mode.
1 E-STD ↔ 2 ES-CLUB ↔ 3 ES-LIVE ↔
4 E-WIDE ↔ 5 EW-CLUB ↔ 6 EW-LIVE ↔
7 LIVE ↔ 8 CLUB ↔ off
- 3 Press **(5)** (↔).



- 4 Rotate the dial to select the desired effect level.

Effect 1 ↔ Effect 2 ↔ Effect 3 ↔ Effect 4 ↔
Effect 5

If you want to change the DSO mode to be adjusted at this time, press **(2)** (↔) to return to step 2.

To restore the factory-set equalizer curve, press **(6)** (ENTER) for two seconds.

- 5 Press **(SOUND)** for two seconds.
When the effect setting is complete, the normal playback mode appears.

Adjusting the balance (BAL)

You can adjust the sound balance from the left and right speakers.

- 1 Press **(SOURCE)** to select a source (tuner, CD, or MD).
- 2 Press **(SOUND)** repeatedly until "BAL" appears.



- 3 Rotate the dial to adjust the balance.
After three seconds, the display returns to the normal playback mode.

Adjusting the fader (FAD)

Normally, with the DSP mode on, the volume of the output sound from the front and rear speakers is lowered automatically to improve the efficiency of the listening position setting. If you want to raise the front and rear speaker volume, adjust the fader.

- 1 Press **(SOURCE)** to select a source (tuner, CD, or MD).
- 2 Press **(SOUND)** repeatedly to select the "F" for the front speakers or "R" for the rear speakers.



- 3 Rotate the dial to adjust the volume of front/rear speakers.

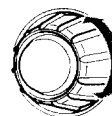

Decreases speaker volume

Increases speaker volume

After three seconds, the display returns to the normal playback mode.

Selecting the cut-off frequency of the front/rear speakers

- 1 Press **(SOUND)** for two seconds.
- 2 Press **(SOUND)** repeatedly to select "F" or "R."
- 3 Press **(5) (→)**.



- 4 Rotate the dial to select the cut-off frequency.

off ↔ 78 Hz ↔ 99 Hz ↔ 125 Hz ↔ 157 Hz
↔ 198 Hz

If you want to adjust the volume of the front or rear speakers at this time, press **(2)** (←) and rotate the dial as in step 2 of "Adjusting the fader (FAD)."

Press **(SOUND)** for two seconds. When the effect setting is complete, the normal playback mode appears.

Adjusting the volume of the subwoofer(s)

- 1 Press **(SOURCE)** to select a source (tuner, CD, or MD).
- 2 Press **(SOUND)** repeatedly until "SUB" appears.



- 3 Rotate the dial to adjust the volume. After three seconds, the display returns to the normal playback mode.

Tip
When you rotate the dial to turn the volume all the way down, "Sub ATT" appears and the cutout frequency of the subwoofer is disabled.

Adjusting the frequency of the subwoofer(s)

To match the characteristics of the connected subwoofer(s), you can cut out the unwanted high and middle frequency signals entering the subwoofer(s). By setting the cut-off frequency (see the diagram below), the subwoofer(s) will output only low frequency signals so you can get a clearer sound image.

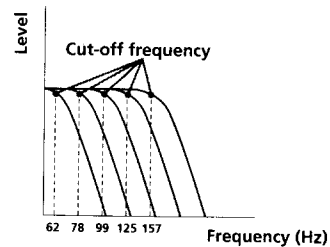

- 1 Press **(SOUND)** for two seconds.
- 2 Press **(SOUND)** repeatedly until "SUB" appears.
- 3 Press **(5) (→)**.



4 Rotate the dial to select the desired cut-off frequency.

The cut-off frequency in the display changes as follows:

62 Hz ↔ 78 Hz ↔ 99 Hz ↔ 125 Hz ↔ 157 Hz
↔ off

If you want to adjust the volume of the subwoofer(s), press **(2)** (←) and rotate the dial as in step 3 of "Adjusting the volume of the subwoofer(s)."

5 Press **(SOUND) for two seconds.**

After the frequency setting is complete, the display returns to the normal playback mode.

Listening to each program source in its registered DSO

— Source Sound Memory (SSM)

Each time you return to the same source, you can hear the same DSO menu and equalizer curve registered for that source, even after changing the program source or turning the unit off and then on again.

Other Functions

Using the rotary commander

The rotary commander works by pressing buttons and/or rotating controls. You can also control the optional CD or MD units with the rotary commander.

By pressing buttons (the **SOURCE** and **MODE** buttons)

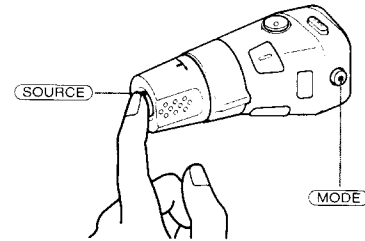

Each time you press **(SOURCE)**, the source changes as follows:

TUNER → CD → MD → TV*

* When an optional TV tuner or video is connected.

Pressing **(MODE)** changes the operation in the following ways;

- Tuner : FM1 → FM2 → AM
- CD unit : CD1 → CD2 → ...
- MD unit : MD1 → MD2 → ...
- TV/Video : TV → VIDEO1 → VIDEO2 → ...

Rotating the control (the SEEK/MS control)

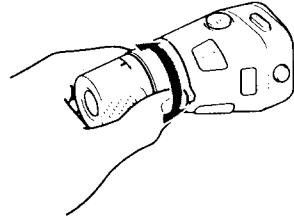

Rotate the control momentarily and release it to:

- Locate a specific track on a disc. Rotate and hold the control until you locate the specific point in a track, then release it to start playback.
- Tune in stations automatically. Rotate and hold the control to tune in a specific station.

Pushing in and rotating the control (the PRESET/DISC control)

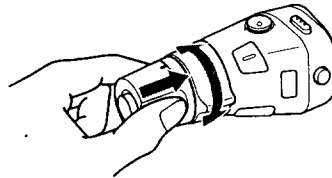

Push in and rotate the control to:

- Receive the stations memorized on the number buttons.
- Change the disc.

Other operations

Rotate the VOL control to adjust the volume.

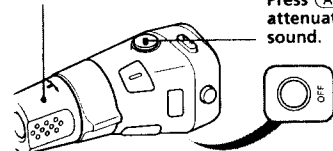

Press **(ATT)** to attenuate the sound.

Press **(OFF)** to turn off the unit.

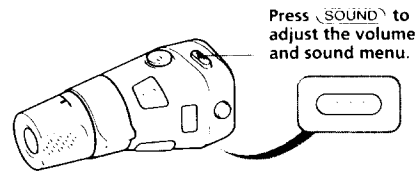

Press **(SOUND)** to adjust the volume and sound menu.

Press **(LIST)** to display the memorised names.

Press **(REC)** to record a voice memo.

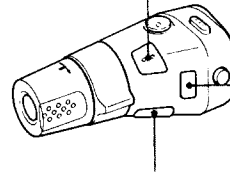

Press and hold **(TALK)** to select a "V Drive" box for registration.

- Press to:
- Register a vocal phrase.
 - Request a registered source.

Press **(PLAY)** to play back the voice memo. Press and hold **(PLAY)** to erase the voice memo.

Changing the operative direction

The operative direction of controls is factory-set as in the illustration below.

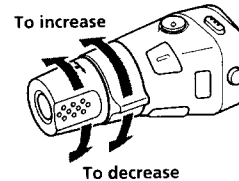

If you need to mount the rotary commander on the right side of the steering column, you can reverse the operative direction.

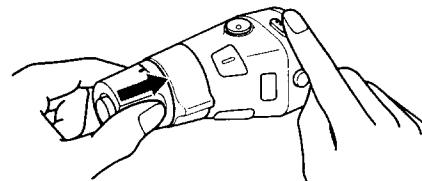

Press **(SOUND)** for two seconds while pushing the VOL control.

Tip
You can control the operative direction of controls with the unit (page 25).

Attenuating the sound

Press **ATT** on the rotary commander or optional wireless remote.

"ATT on" appears momentarily.

To restore the previous volume level, press

ATT again.

Tip

When the interface cable of a car telephone is connected to the ATT lead, the unit decreases the volume automatically when a telephone call comes in (Telephone ATT function).

Changing the sound and display settings

The following items can be set:

- Clock (page 8).
- D.Info (Dual Information) – to display the clock and the play mode at the same time (ON) or to display the information alternately (OFF).
- SA (Spectrum Analyzer) – to change the display pattern of the equalizer display.
- Amber/Green – to change the illumination color to amber or green.
- Dimmer – to change the brightness of the display.
 - Select "Auto" to dim the display only when you turn the lights on.
 - Select "on" to dim the display.
 - Select "off" to deactivate Dimmer.
- Contrast – to adjust the contrast if the indications in the display are not recognizable because of the unit's installed position.
- Voice guide function for vocalized comments.
 - Select "Voice 1" to minimize the volume of the guide.
 - Select "Voice 2" to increase the volume than "Voice 1."
 - Select "Voice 3" to maximize the volume of the guide.
 - Select "Voice off" to deactivate Voice guide.
- Beep – to turn on or off the beeps.
- RM (Rotary Commander) – to change the operative direction of the controls of the rotary commander.
 - Select "norm" to use the rotary commander as the factory-set position.
 - Select "rev" when you mount the rotary commander on the right side of the steering column.
- M.dspl (Motion Display) – to turn the motion display to 1, 2, or off.
- English/French - to change the vocalized comments of the voice guide and the display language to English or French.
- A.Scr1 (Auto Scroll) (page 10, 27).

1 Press **(SHIFT)**.

2 Press **(SET UP)** repeatedly until the desired item appears.

Each time you press **(SET UP)**, the item changes as follows:

Clock → D.Info → SA → Amber/Green →
Dimmer → Contrast → Voice → Beep → RM
→ M.dspl → English/French → A.Scrf

When you have not tune the station or there is no CD/MD being played, these items will not appear.

Note

The displayed item will differ depending on the source.

3 Press **(→)** to select the desired setting (for example: on or off).

For the "Contrast" setting, pressing **(→)** makes the contrast higher, and pressing **(←)** makes the contrast lower.

• Press **(SHIFT)**.

After the mode setting is complete, the display returns to the normal playback mode.

Changing the equalizer display

You can change the equalizer display according to the music you are listening to.

Selecting the display pattern

Press **(SOURCE)** to select a source (tuner, CD, or MD).

Press **(DSPL/SA)** for two seconds repeatedly to select the desired display pattern.

SA 1 → SA 2 → SA 3 → SA 4 → SA 5 → SA 6
→ SA AUTO → SA off

With Optional Equipment CD/MD Unit

You can control up to seven CD and MD units with this unit.

If you connect an optional CD unit with the CD TEXT function, the CD TEXT information will appear in the display when you play back a CD TEXT disc.

Playing a CD or MD

1 Press **(SOURCE)** repeatedly to select the CD or MD.

2 Press **(MODE)** until the desired unit appears.
CD/MD playback starts.

When a CD/MD unit is connected, all the tracks play from the beginning.

Changing the display item

Each time you press **(DSPL/SA)** during CD, CD TEXT, or MD playback, the item changes as follows:

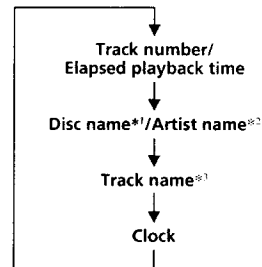

*1 If you have not labeled the disc or if there is no disc name prerecorded on the MD, "NO D.Name" appears in the display.

*2 If you play a CD TEXT disc, the artist name appears in the display after the disc name. (Only for CD TEXT discs with the artist name.)

*3 If the track name of a CD TEXT disc or MD is not prerecorded, "NO T.Name" appears in the display.

You can label CD and CD TEXT discs with a personalized name using the disc memo function, refer to "Labeling a CD" (page 31). However, if you use personalized labels, they will always take priority over the original CD TEXT information when such information is displayed.

Tips

- If the name of the MD or CD TEXT disc is too long, you can scroll it across the display by pressing **[SHIFT]**, then **[←]**.
- If you want to display the original CD TEXT information after labeling the CD TEXT disc with a personalized name, press **[SHIFT]**, then **[5]** (**[→]**).

After you select the desired item, the display will automatically change to the Motion Display mode after a few seconds. In the Motion Display mode, all the above items are scrolled in the display one by one in order.

Tip

The Motion Display mode can be turned off. (See "Changing the sound and display settings" on page 25.)

Automatically scrolling a disc name

— Auto Scroll

If the disc name/artist name or track name on a CD TEXT disc or MD exceeds 10 characters and the Auto Scroll function is on, the following automatically scrolls on the display:

- The disc name appears when the disc has changed (if the disc name is selected).
- The track name appears when the track has changed (if the track name is selected).

If you press **[DSPL/SA]** to change the display item, the disc or track name of the MD or CD TEXT disc is scrolled automatically whether you set the function on or off.

- 1** During playback, press **[SHIFT]**.
- 2** Press **[3]** (**[SET UP]**) repeatedly until "A.Scr" appears.
- 3** Press **[5]** (**[→]**) to select "A.Scr on."
- 4** Press **[SHIFT]**

To cancel Auto Scroll, select "A.Scr off" in step 3 above.

Note

For some CD TEXT discs with a lot of characters, the following cases may happen:
— Some of the characters are not displayed.
— Auto Scroll does not work.

Locating a specific track

— Automatic Music Sensor (AMS)

During playback, push the SEEK/AMS control up or down once for each track you want to skip.

To locate succeeding tracks



To locate preceding tracks

Locating a specific point in a track

— Manual Search

During playback, push the SEEK/AMS control up or down and hold. Release when you have found the desired point.

To search forward



To search backward

Locating a disc by disc number

— Direct Disc Selection

Press the number button (**[1]** to **[10]**) that corresponds with the desired disc number.

The desired disc in the current unit begins playback.

Playing tracks repeatedly

Repeat Play

You can select:

- Repeat 1 – to repeat a track.
- Repeat 2 – to repeat a disc.

During playback, press **(SHIFT)**.

Press **(7)** (REP) repeatedly until the desired setting appears.

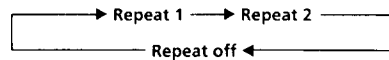

Repeat Play starts.

Press **(SHIFT)**.

return to the normal playback mode, select repeat off" in step 2 above.

Playing tracks in random order — Shuffle Play

You can select:

- Shuf 1 – to play the tracks on the current disc in random order.
- Shuf 2 – to play the tracks in the current unit in random order.
- Shuf All – to play all the tracks in random order.

During playback, press **(SHIFT)**.

Press **(8)** (SHUF) repeatedly until the desired setting appears.

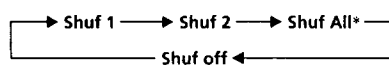

Shuffle Play starts.

* "Shuf All" is only available when you connect one or more optional MD units, or when you connect two or more optional CD units.

Press **(SHIFT)**.

return to the normal playback mode, select shuf off" in step 2 above.

Creating a program

— Program Memory (CD/MD unit with the program memory function)

You can play tracks in any order you want by making your own programs. You can select up to 24 tracks for a program. You can store the programs in memory.

1 During CD/MD playback, press **(SHIFT)**, then press **(4)** (PLAY MODE) for two seconds.

Program edit mode



If you have labeled the disc, the bank edit mode appears. Press **(4)** (PLAY MODE) to display "P" above.

2 Select the track you want.

- Press **(SOURCE)** repeatedly to select CD or MD.
- Press **(MODE)** repeatedly to select the unit.
- Press **(SHIFT)**, then press the number button (**(1)** to **(10)**) to select the disc.
- Press **(SHIFT)**.
- Push the SEEK/AMS control up or down to select the track.

3 Press **(6)** (ENTER) momentarily.

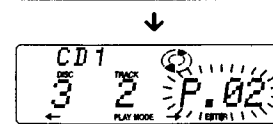

4 To continue entering tracks, repeat steps 2 and 3.

5 When you finish entering tracks, press **(4)** (PLAY MODE) for two seconds.

6 Press **(SHIFT)**.

Notes

- "Wait" appears in the display while the unit is reading the data, or when a disc has not been put into the unit.
- "Mem Full" appears in the display when you try to enter more than 24 tracks into a program.

Playing the stored program

Changing the disc order in the unit will not affect program memory play.

- 1 Press (SHIFT).
- 2 Press (4) (PLAY MODE) repeatedly until "PGM" appears.
- 3 Press (5) (→) repeatedly until "PGM on" appears.



Program Play starts.

- 4 Press (SHIFT).

To return to the normal playback mode, select "PGM off" in step 3 above.

Notes

- If you press a number button during program memory play, program memory play is interrupted, and playback of the selected disc starts.
- "NO Data" appears in the display if no track is stored in the program.
- If a track stored into the program memory is not in the disc magazine, the track will be skipped.
- When the disc magazine contains no tracks - stored into the program memory, or when the program information has not been loaded yet, "Not ready" appears.

Erasing an entire program

- 1 Press (SHIFT), then press (4) (PLAY MODE) for two seconds.

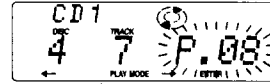

If you have labeled the disc, the bank edit mode appears. Press (4) (PLAY MODE) to display "P" above.

- 2 Press (2) (←) repeatedly until "DEL" appears.



- 3 Press (6) (ENTER) for two seconds.



The entire program is erased.

- 4 When you finish erasing programs, press (4) (PLAY MODE) for two seconds.
- 5 Press (SHIFT).

Adding tracks to a program

Press **(SHIFT)**, then press **(4)** (PLAY MODE) for two seconds.



If you have labeled the disc, the bank edit mode appears. Press **(4)** (PLAY MODE) to display "P" above.

Press **(2)** (←) or **(5)** (→) to select the track slot number where you want to insert a track.

Track slot number

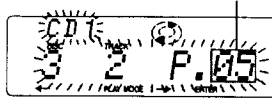

Push the SEEK/AMS control up or down to select the track you want to insert.

Press **(6)** (ENTER) momentarily to enter the track.

The current track is inserted in that slot number and the succeeding tracks shift down.

To continue inserting tracks, repeat steps 2 through 4.

Note

Once all 24 slots have been filled, "*Mem Full*" appears in the display, and you cannot insert more tracks.

When you finish inserting tracks, press **(4)** (PLAY MODE) for two seconds.

Press **(SHIFT)**.

Erasing tracks in a program

1 Press **(SHIFT)**, then press **(4)** (PLAY MODE) for two seconds.



If you have labeled the disc, the bank edit mode appears. Press **(4)** (PLAY MODE) to display "P" above.

2 Press **(2)** (←) or **(5)** (→) to select the track you want to erase.

Track slot number

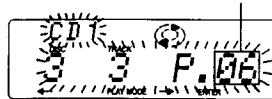

The track currently registered in slot 6.

3 Press **(6)** (ENTER) for two seconds.

When you erase a track from a slot number, the succeeding tracks shift up to fill the gap.

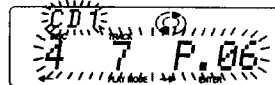
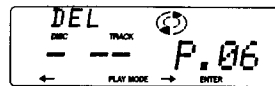

4 To continue erasing tracks, repeat steps 2 and 3.

5 When you finish erasing tracks, press **(4)** (PLAY MODE) for two seconds.

6 Press **(SHIFT)**.

Labeling a CD — Disc Memo (CD unit with the custom file function)

You can label each disc with a personalized name. You can enter up to eight characters for a disc. If you label a CD, you can locate the disc by name (page 32) and select the specific tracks for playback (page 33).

- 1 Play the CD and press **(LIST)** for two seconds.

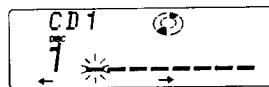

- 2 Enter the characters.

- 1 Rotate the dial clockwise to select the desired characters.
(A → B → C → ... Z → 0 → 1 → 2 → ... 9 → + → - → * → / → \ → > → < → . → _)

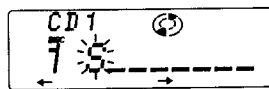

If you rotate the dial counterclockwise, the characters appear in the reverse order.

If you want to put a blank space between characters, select “_” (under-bar).

- 2 Press **(→)** after locating the desired character.

The flashing cursor moves to the next space.

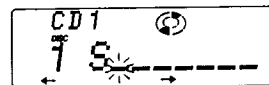

If you press **(←)**, the flashing cursor moves to the left.

- 3 Repeat steps 1 and 2 to enter the entire name.

- 3 To return to the normal CD playback mode, press **(LIST)** for two seconds.

Tip

To erase or correct a name enter “_” (under-bar) for each character.

Displaying the disc memo name

Press **(DSP/USA)** during CD or CD TEXT disc playback.

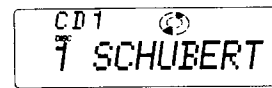

Each time you press **(DSP/USA)** during CD or CD TEXT playback, the item changes as follows:

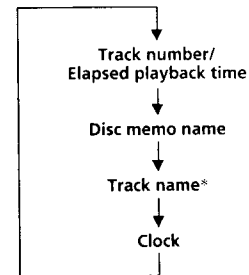

* If you connect an optional CD unit with the CD TEXT function, the CD TEXT information will appear in the display when you playback a CD TEXT disc.

After you select the desired item, the display will automatically change to the Motion Display mode after a few seconds. In the Motion Display mode, all the above items are scrolled in the display one by one in order.

Tip

The Motion Display mode can be turned off. (See “Changing the sound and display settings” on page 25.)

Erasing the disc memo

- Press (SOURCE) repeatedly to select CD.
- Press (MODE) repeatedly to select the CD unit.
- Press (LIST) for two seconds.
- Press (DSPL/SA) for two seconds.
- Rotate the dial to select the name you want to erase.
- Press (6) (ENTER) for two seconds.
The name is erased.
Repeat steps 5 and 6 if you want to erase other names.
- Press (LIST) for two seconds.
The unit returns to the normal CD playback mode.

Note
When the personalized label is erased, the original CD TEXT information will appear in the display.

Locating a disc by name

— List-up (CD unit with the custom file function or MD unit)

You can use this function for discs that have been assigned a custom name. For more information on disc names, refer to "Labeling a CD" (page 31).

- 1 Press (LIST) momentarily.
The name assigned to the current disc appears in the display.



When you assign a disc memo label to a CD TEXT disc, it takes priority over the original CD TEXT information.

- 2 Press (LIST) repeatedly until you find the desired disc.
- 3 Press (6) (ENTER) to play back the disc.

Notes

- After a disc name has been displayed for five seconds, the display returns to normal playback mode. To turn off the display, press (DSPL/SA).
- The track names are not displayed during MD or CD TEXT disc playback.
- If there are no discs in the magazine, "NO Disc" appears in the display.
- If a disc has not been assigned a custom file, "*****" appears in the display.
- If the disc information has not been read by the unit, "?" appears in the display. To load a disc, first press the number button, then choose the disc that has not been loaded.
- The information appears only in upper case. There are also some letters which cannot be displayed (during MD or CD TEXT disc playback).

Selecting specific tracks for playback

— Bank (CD unit with the custom file function)

If you label the disc, you can set the unit to skip tracks and play only the tracks you want.

- 1 Start playing the disc and press **(SHIFT)**. Then press **(4)** (PLAY MODE) for two seconds.

Bank edit mode



Note

If you have not labeled the disc, the bank edit mode does not appear and the program edit mode appears. To return to the normal playback mode, press **(4)** (PLAY MODE) for two seconds.

- 2 Push the SEEK/AMS control up or down to select the track number you want to skip and press **(6)** (ENTER).



The indication changes from "Play" to "Skip." To return the indication to "Play," press **(6)** (ENTER) again.

- 3 Repeat step 2 to set "Play" or "Skip" mode on all the tracks.
- 4 Press **(4)** (PLAY MODE) for two seconds. The unit returns to the normal CD playback mode.
- 5 Press **(SHIFT)**.

Notes

- You can set the "Play" and "Skip" mode for up to 24 tracks.
- You cannot set the "Skip" mode for all the tracks.

Playing the specific tracks only

You can select:

- Bank on – to play the tracks with the "Play" setting.
- Bank inv (Inverse) – to play the tracks with the "Skip" setting.

- 1 During playback, press **(SHIFT)**, then press **(4)** (PLAY MODE) repeatedly until "Bank" appears.

- 2 Press **(5)** (→) repeatedly until the desired setting appears.

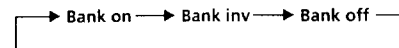

Playback starts from the track following the current one.

- 3 Press **(SHIFT)**.

To return to the normal play mode, select "Bank off" in step 2 above.

With Optional Equipment TV/Video

You can connect an optional TV tuner and TV monitor to this unit.

Watching the TV

- 1 Press **(SOURCE)** repeatedly until "TV" appears.
- 2 Push the SEEK/AMS control up or down to select the desired TV band.

Watching a video

- 1 Press **(SOURCE)** repeatedly until "TV" appears.
- 2 Press **(MODE)** repeatedly to select "Video 1."
Play back the video.

Note
"Video 2" appears if the VIDEO 2 terminal of the TV monitor is selected.

Memorizing TV channels automatically

The unit selects the TV channels with the strongest signals and memorizes them in the order of their frequency.

Caution

When tuning in a station while driving, use Best Tuning Memory to prevent accidents.

- 1 Press **(SOURCE)** repeatedly until "TV" appears.
- 2 Press **(SHIFT)**, then press **(4)** (PLAY MODE) repeatedly until "Auto mem" appears.

- 3 Press **(5)** (→).

The unit stores TV channels in the order of their frequencies on the number buttons. A beep sound and the setting is stored.

- 4 Press **(SHIFT)**.

Notes

- The unit does not store TV channels with weak signals. If only a few TV channels are received, some number buttons will remain empty.
- When a preset number is indicated in the display, the unit starts storing TV channels from the one currently displayed.

Memorizing only the desired TV channels

You can store up to 10 channels on the number buttons in the order of your choice.

- 1 Press **(SOURCE)** repeatedly until "TV" appears.
- 2 Push the SEEK/AMS control up or down to tune in the TV program you want to store on the number button.
- 3 Keep the desired number button (**(1)** to **(10)**) pressed until you hear a beep tone. The number button indication appears in the display.

Note

If you try to store another program on the same number button, the previously stored program will be erased.

Storing the TV channel names

Follow the steps in "Storing the station names" (page 14).

Displaying the TV or radio station names

Press **(LIST)** momentarily during TV or radio reception.

Example: When receiving the FM1 band

FM 1	
1	- WCBS
2	- WBLS
3	- WKTU
4	- WRKISS
5	- WEVD
6	- WRFM
7	- 101.9
8	- 102.7
9	- WPLJ
10	- WYNY

- ① Preset number
- ② Stored station names
- ③ Frequencies*

* If the name of a station is not stored, the frequency of that station will be displayed instead.

Notes

- It may take some time before all indications appear in the display.
- The TV program does not appear during list display.
- The contents of the preset memory cannot be listed when the unit is in the simultaneous play mode (page 36).

Turning off the display

During radio reception, press **(LIST)** again.

During TV reception, the list display on the TV monitor will automatically turn off after a few seconds.

Displaying the information stored on discs

Press **(LIST)** momentarily during CD/MD playback.

Example: When CD unit 1 is selected.

CD 1	
1	- SCHUBERT
2	- MOZART
3	- BACH
4	- LISZT
5	- CHOPIN
6	- *****
7	- *****
8	- ?
9	- ?
10	- ?

- ① Disc numbers
- ② Titles stored as custom files
- ③ No disc is loaded*¹
- ④ No stored titles*²
- ⑤ TOC information has not been identified yet*³

*¹ A blank space is displayed next to a disc numbers representing empty slots in the disc magazine.

*² If a title is not registered in the custom file, "*****" is displayed.

*³ If the disc information has not been read yet, "?" is displayed.

Notes

- It may take some time until all indications appear in the display.
- The TV program does not appear during list display.
- The contents of the preset memory cannot be listed when the unit is in the simultaneous play mode.

Turning off the display

Press **(LIST)** again.

Watching the TV or video while listening to a CD or MD — Simultaneous Play

The simultaneous play function does not work while you are listening to the radio.

- 1 Press **(SOURCE)** for two seconds.

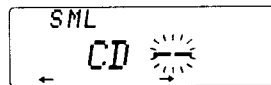

- 2 Press **(2) (←)**.

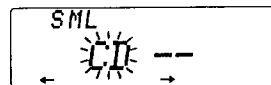

- 3 Press **(SOURCE)** repeatedly to select a CD or MD.

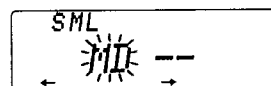

- 4 Press **(5) (→)**.

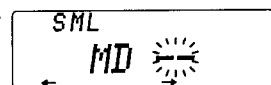

- 5 Press **(SOURCE)** repeatedly to select a TV or video.

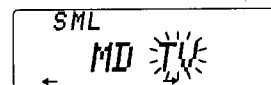

- 6 Press **(SOURCE)** for two seconds. Simultaneous Play starts.

If you are already watching the TV or video and want to listen to a CD or MD, follow the same above steps except press **(5) (→)** in step 2 and press **(2) (←)** in step 4.

Returning to normal mode

To cancel the CD or MD, follow the steps above and select "--" in step 3.

To cancel the TV or video, follow the steps above and select "--" in step 5.

Notes

If you press the *EJECT* button on a CD/MD unit while the unit is in simultaneous play mode, Simultaneous Play is canceled.

Additional Information

Precautions

- If your car was parked in direct sunlight resulting in a considerable rise in temperature inside the car, allow the unit to cool off before operating it.
- If no power is being supplied to the unit, check the connections first. If everything is in order, check the fuse.
- If no sound comes from the speaker systems, set the fader control to the center position.
- If your car is equipped with a power antenna, it will extend automatically while the unit is operating.

If you have any questions or problems concerning your unit that are not covered in this manual, please consult your nearest Sony dealer.

Note on moisture condensation

On a rainy day or in a very damp area, moisture may condense on the lenses inside the MD player. Should this occur, the unit will not operate properly. In this case, remove the disc and wait for about an hour until the moisture evaporates.

Maintenance

Fuse replacement

When replacing the fuse, be sure to use one that matches the amperage described on the fuse. If the fuse blows, check the power connection and replace the fuse. If the fuse blows again after replacement, there may be an internal malfunction. In such a case, consult your nearest Sony dealer.

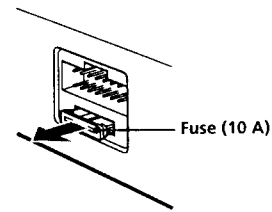

Warning

Never use a fuse with an amperage rating exceeding the one supplied with the unit as this could damage the unit.

Cleaning the connectors

The unit may not function properly if the connectors between the unit and the front panel are not clean. To prevent this, open the front panel by pressing **OPEN**, then detach it and clean the connectors with a cotton swab dipped in alcohol. Do not apply too much force. Otherwise, the connectors may be damaged.

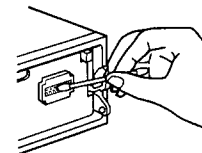

Main unit

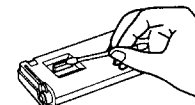

Back of the front panel

Notes

- For safety, before cleaning the connectors, turn off the engine and remove the key from the ignition switch.
- Never touch the connectors directly with your fingers or any metal device.

Dismounting the unit

- 1 Press the clip inside the front cover with a thin screwdriver, and gently pry the front cover free.

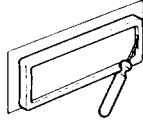

- 2 Repeat step 1 on the left side.
The front cover is removed.

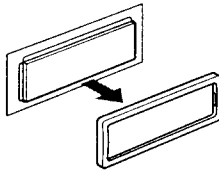

- 3 Use a thin screwdriver to push in the clip on the left side of the unit, then pull out the left side of the unit until the catch clears the mounting.

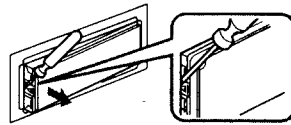

- 4 Repeat step 3 on the right side.

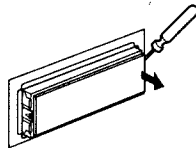

- 5 Slide the unit out of the mounting.

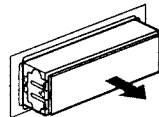

Specifications

AUDIO POWER SPECIFICATIONS

POWER OUTPUT AND TOTAL HARMONIC DISTORTION

19 watts per channel minimum continuous average power into 4 ohms, 4 channels driven from 20 Hz to 20 kHz with no more than 1% total harmonic distortion.

Other specifications

MD player section

Signal-to-noise ratio	93 dB
Frequency response	10 - 20,000 Hz
Wow and flutter	Below measurable limit
Laser Diode Properties	
Material	GaAlAs
Wavelength	780 nm
Emission Duration	Continuous
Laser output power	Less than 44.6 W*

* This output is the value measured at a distance of 200 mm from the objective lens surface on the Optical Pick-up Block.

Tuner section

FM

Tuning range	87.5 - 107.9 MHz
Antenna terminal	External antenna connector
Intermediate frequency	10.7 MHz
Usable sensitivity	8 dBf
Selectivity	75 dB at 400 kHz
Signal-to-noise ratio	65 dB (stereo), 68 dB (mono)
Harmonic distortion at 1 kHz	0.7 % (stereo), 0.4 % (mono)
Separation	35 dB at 1 kHz
Frequency response	30 - 15,000 Hz

AM

Tuning range	530 - 1,710 kHz
Antenna terminal	External antenna connector
Intermediate frequency	10.71 MHz/450 kHz
Sensitivity	30 μ V

Power amplifier section

Outputs	Speaker outputs (sure seal connectors)
Speaker impedance	4 - 8 ohms
Maximum power output	45 W \times 4 (at 4 ohms)

General

Outputs	Line outputs (3) Power antenna relay control lead Power amplifier control lead Telephone ATT control lead Illumination control lead
Equalizer	\pm 12 dB; fo = 62 Hz, 157 Hz, 396 Hz, 1.0 kHz, 2.51 kHz, 6.34 kHz, 16 kHz
Power requirements	12 V DC car battery (negative ground)
Dimensions	Approx. 178 \times 50 \times 182 mm (7 ¹ / ₈ \times 2 \times 7 ¹ / ₄ in.) (w/h/d)
Mounting dimensions	Approx. 182 \times 53 \times 163 mm (7 ¹ / ₄ \times 2 ¹ / ₈ \times 6 ¹ / ₂ in.) (w/h/d)
Mass	Approx. 1.3 kg (2 lb. 13.9 oz.)
Supplied accessories	Rotary commander RM-X4V (1) Microphone (1) Parts for installation and connections (1 set) Front panel case (1)
Optional accessories	BUS cable (supplied with an RCA pin cord) RC-61 (1 m), RC-62 (2 m) Wireless remote RM-X47
Optional equipment	CD changer CDX-828 (10 discs), CDX-727 (10 discs) MD changer MDX-65 (6 discs) Other CD/MD changers with the Sony-Bus system Source selector XA-C30 TV tuner XT-40V, etc.

US and foreign patents licensed from Dolby Laboratories Licensing Corporation.

Design and specifications are subject to change without notice.

Troubleshooting guide

The following checklist will help you remedy the problems you may encounter with your unit. Before going through the checklist below, check the connection and operating procedures.

General

Problem	Cause/Solution
No sound.	<ul style="list-style-type: none">• Cancel the ATT function.• Set the fader control to the center position for speaker systems.• Rotate the dial clockwise to adjust the volume.
The contents of the memory have been erased.	<ul style="list-style-type: none">• The power cord or battery has been disconnected.• The reset button has been pressed. → Store again into the memory.
Indications do not appear in the display.	Remove the front panel and clean the connectors. See "Cleaning the connectors" (page 37) for details.

CD/MD playback

Problem	Cause/Solution
A disc cannot be loaded.	<ul style="list-style-type: none">• Another MD is already loaded.• The MD is forcibly inserted upside down or in the wrong way (CD).
Playback does not begin.	Defective MD or dusty CD.
A disc is automatically ejected.	The ambient temperature exceeds 50°C (122°F).
The operation buttons do not function.	Press the reset button.
The sound skips due to vibration.	<ul style="list-style-type: none">• The unit is installed at an angle of more than 20°.• The unit is not installed in a sturdy part of the car.

Radio reception

Problem	Cause/Solution
Presets tuning is not possible.	<ul style="list-style-type: none">• Memorize the correct frequency.• The broadcast signal is too weak.
Automatic tuning is not possible.	The broadcast signal is too weak. → Use manual tuning.
The stations cannot be received. The sound is hampered by noises.	Connect a power antenna control lead (blue) or accessory power input lead (red) to the power supply lead of a car's antenna booster. (When your car has built-in FM/AM antenna in the rear/side glass only.)
The "ST" indication flashes.	<ul style="list-style-type: none">• Tune in the frequency accurately.• The broadcast signal is too weak. → Set to Mono mode (page 14).
Interference occurs during FM reception.	The Wide mode is selected. → Set to the Narrow or IF Auto mode. (page 14)

Voice drive/ Voice memo

Problem	Cause/Solution
Registering a vocal phrase or recording a voice memo is not possible.	The microphone is not connected properly. → Plug it in completely.
The unit often fails or does not succeed in recognising the vocal phrase.	<ul style="list-style-type: none">• The microphone may not be able to receive the driver's voice depending on the installation location and direction due to the microphone's sharp directivity. → Install the microphone properly. Be sure to adjust the SONY mark facing towards the driver's mouth.• The unit incorporates outside noises as a part of the vocal phrase. → Close the window while registering a vocal phrase.• You can make it easier for the unit to recognise the vocal phrase by pronouncing the phrase clearly and loudly.• The phrase that you pronounced is different from the registered one. → Pronounce the registered phrase.
Vocalised instructions are not heard while the voice drive function or the voice memo function is engaged in another operation.	The volume setting is at the lowest. → Adjust the volume with the dial of the unit.

DSP functions

Problem	Cause/Solution
No sound, or sound is too low.	The volume of the rear speakers may have been automatically lowered in order to maximize the effect of the listening position adjustment. → Rotate the dial to adjust the balance. The speaker balance can be set separately for DSP on mode and DSP off mode (page 21).

Error displays (when an optional CD/MD unit is connected)

The following indications will flash for about five seconds, and an alarm sound will be heard.

Display	Cause	Solution
NO Mag	The disc magazine is not inserted in the CD/MD unit.	Insert the disc magazine in the CD/MD unit.
NO Disc	No disc is inserted in the CD/MD unit.	Insert discs in the CD/MD unit.
NG Discs	A CD/MD cannot play because of some problem.	Insert another CD/MD.
Error ^{*1}	A CD is dirty or inserted upside down.* ²	Clean or insert the CD correctly.
	An MD does not play because of some problem.* ²	Insert another MD.
Blank ^{*1}	No tracks have been recorded on an MD.* ²	Play an MD with tracks recorded on it.
PushReset	The CD/MD unit cannot be operated because of some problem.	Press the reset button of the unit.
Not Ready	The lid of the MD unit is open or MDs are not inserted properly.	Close the lid or insert the MDs properly.
HighTemp	The ambient temperature is more than 50°C (122°F).	Wait until the temperature goes down below 50°C (122°F).

^{*1} When an error occurs during playback of an CD or MD, the disc number of the CD or MD does not appear in the display.

^{*2} The disc number of the disc causing the error appears in the display.

If the above-mentioned solutions do not help improve the situation, consult your nearest Sony dealer.

